



# CHENMKO ENTERPRISE CO.,LTD

**GLASS PASSIVATED JUNCTION TRANSIENT VOLTAGE SUPPRESSOR**  
**VOLTAGE-6.8 TO 200 VOLTS**  
**600 WATTS PEAK POWER 5.0 WATTS STEADY STATE**

**P6SBMJ**  
**SERIES**

*Halogens free devices*

### FEATURES

- \* Plastic package
- \* 600W surge capability at 1ms
- \* Glass passivated chip junction in SMB Package
- \* Excellent clamping capability
- \* Low Zener Impedance
- \* Fast response time: typically less than 1.0ps from 0 volts to BV min.
- \* Typical IR less than 1 uA above 10V
- \* High temperature soldering guaranteed : 260°C/10 seconds at terminals

### MECHANICAL DATA

**Case:** JEDEC SMB molded plastic  
**Terminals:** Plated axial leads, solderable per MIL-STD-750, Method 2026  
**Polarity:** Color band denotes cathode end  
**Mounting Position:** Any  
**Weight:** 0.003 ounce 0.093 gram



SMB

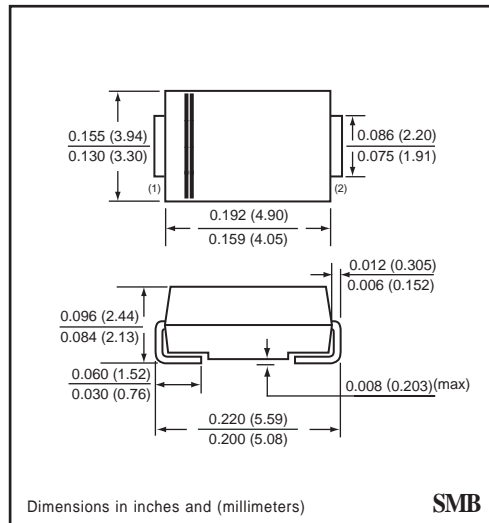

SMB

### MAXIMUM RATINGS AND ELECTRICAL CHARACTERISTICS

Ratings at 25°C ambient temperature unless otherwise specified.  
 Single phase, half wave, 60 Hz, resistive or inductive load.  
 For capacitive load, derate current by 20%.

### DEVICES FOR BIDIRECTIONAL APPLICATIONS

For Bidirectional use C or CA Suffix for types P6SBMJ6.8A thru types P6SBMJ200A  
 Electrical characteristics apply in both directions.

MAXIMUM RATINGS ( At TA = 25°C unless otherwise noted )

RATINGS	SYMBOL	VALUE	UNITS
Peak Power Dissipation at TA = 25°C, Tp = 1ms ( Note1 )	PPK	Minimum 600	Watts
Steady State Power Dissipation at TL = 75°C	PD	5.0	Watts
Peak Forward Surge Current 8.3ms Single Half Sine-Wave Superimposed on Rated Load ( Note 2 )	IFSM	100	Amps
Operating and Storage Temperature Range	TJ, TSTG	-65 to +175	°C

NOTES : 1. Non-repetitive current pulse, per Fig. 3 and derated above TA = 25°C per Fig. 2.  
 2. 8.3ms single half sine-wave, duty cycle = 4 pulses per minute maximum.  
 3. PC Board Mounted on 0.2 X 0.2" ( 5 X 5mm ) copper pad area

2003-01

PRODUCT NO.	Breakdown Voltage				Working Peak Reverse Voltage	Maximum Reverse Leakage at Vrwm	Maximum Reverse Current	Maximum Reverse Voltage at Irsm ( clamping )	Maximum Temperature Coefficient of Vbr
	VBR Volts ( NOTE 1 )			@ IT ( mA )					
	MIN.	NOM.	MAX.		Vrwm ( V )	Ir ( uA )	Irsm ( A )	Vrsm ( V )	( %C )
P6SBMJ6.8AGP	6.45	6.8	7.14	10	5.80	1000	57	10.5	0.057
P6SBMJ7.5AGP	7.13	7.5	7.88	10	6.40	500	53	11.3	0.061
P6SBMJ8.2AGP	7.79	8.2	8.61	10	7.02	200	50	12.1	0.065
P6SBMJ9.1AGP	8.65	9.1	9.55	1.0	7.78	50	45	13.4	0.068
P6SBMJ10AGP	9.5	10	10.5	1.0	8.55	10	41	14.5	0.073
P6SBMJ11AGP	10.5	11	11.6	1.0	9.40	5.0	38	15.6	0.075
P6SBMJ12AGP	11.4	12	12.6	1.0	10.2	5.0	36	16.7	0.078
P6SBMJ13AGP	12.4	13	13.7	1.0	11.1	5.0	33	18.2	0.081
P6SBMJ15AGP	14.3	15	15.8	1.0	12.8	5.0	28	21.2	0.084
P6SBMJ16AGP	15.2	16	16.8	1.0	13.6	5.0	27	22.5	0.086
P6SBMJ18AGP	17.1	18	18.9	1.0	15.3	5.0	24	25.2	0.088
P6SBMJ20AGP	19.0	20	21.0	1.0	17.1	5.0	22	27.7	0.090
P6SBMJ22AGP	20.9	22	23.1	1.0	18.8	5.0	20	30.6	0.092
P6SBMJ24AGP	22.8	24	25.2	1.0	20.5	5.0	18	33.2	0.094
P6SBMJ27AGP	25.7	27	28.4	1.0	23.1	5.0	16	37.5	0.096
P6SBMJ30AGP	28.5	30	31.5	1.0	25.6	5.0	14.4	41.4	0.097
P6SBMJ33AGP	31.4	33	34.7	1.0	28.2	5.0	13.2	45.7	0.098
P6SBMJ36AGP	34.2	36	37.8	1.0	30.8	5.0	12.0	49.9	0.099
P6SBMJ39AGP	37.1	39	41.0	1.0	33.3	5.0	11.2	53.9	0.100
P6SBMJ43AGP	40.9	43	45.2	1.0	36.8	5.0	10.1	59.3	0.101
P6SBMJ47AGP	44.7	47	49.4	1.0	40.2	5.0	9.3	64.8	0.101
P6SBMJ51AGP	48.5	51	53.6	1.0	43.6	5.0	8.6	70.1	0.102
P6SBMJ56AGP	53.2	56	58.8	1.0	47.8	5.0	7.8	77.0	0.103
P6SBMJ62AGP	58.9	62	65.1	1.0	53.0	5.0	7.1	85.0	0.104
P6SBMJ68AGP	64.6	68	71.4	1.0	58.0	5.0	6.5	92.0	0.104
P6SBMJ75AGP	71.3	75	78.8	1.0	64.1	5.0	5.8	103	0.105
P6SBMJ82AGP	77.9	82	86.1	1.0	70.1	5.0	5.3	113	0.105
P6SBMJ91AGP	86.5	91	95.5	1.0	77.8	5.0	4.8	125	0.106
P6SBMJ100AGP	95.0	100	105	1.0	85.5	5.0	4.4	137	0.106
P6SBMJ110AGP	105	110	116	1.0	94.0	5.0	4.0	152	0.107
P6SBMJ120AGP	114	120	126	1.0	102	5.0	3.6	165	0.107
P6SBMJ130AGP	124	130	137	1.0	111	5.0	3.3	179	0.107
P6SBMJ150AGP	143	150	158	1.0	128	5.0	2.9	207	0.108
P6SBMJ160AGP	152	160	168	1.0	136	5.0	2.7	219	0.108
P6SBMJ170AGP	162	170	179	1.0	145	5.0	2.6	234	0.108
P6SBMJ180AGP	171	180	189	1.0	154	5.0	2.4	246	0.108
P6SBMJ200AGP	190	200	210	1.0	171	5.0	2.2	274	0.108

# RATING CHARACTERISTIC CURVES ( P6SBMJ6.8AGP ~ P6SBMJ200AGP )

FIG. 1 - PEAK PULSE POWER RATING CURVE

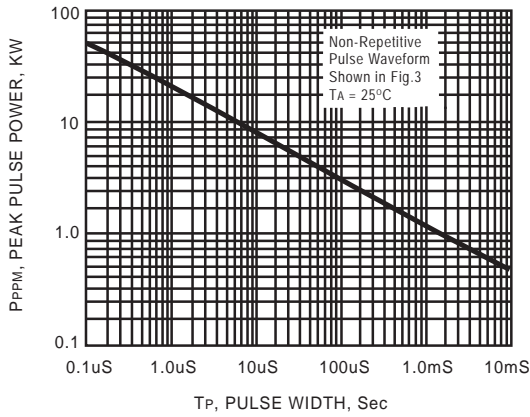

FIG. 2 - PULSE DERATING CURVE

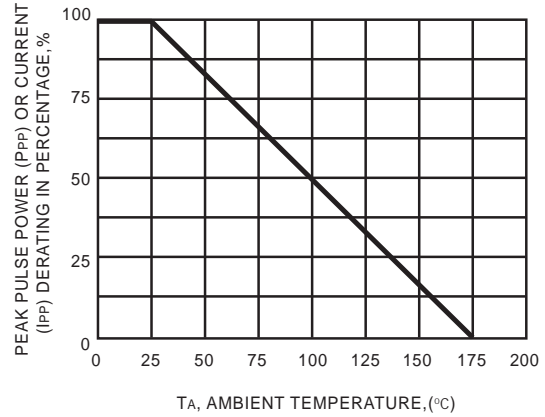

FIG. 3 - PULSE WAVEFORM

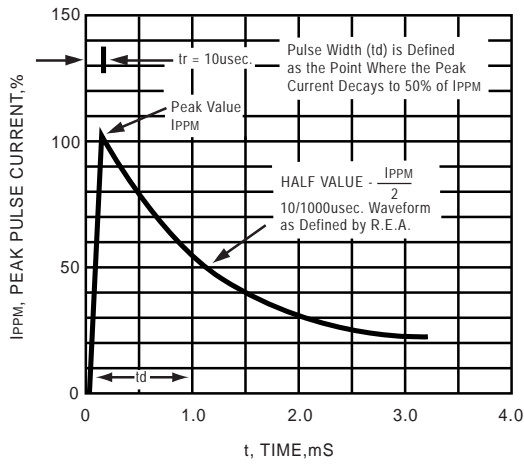
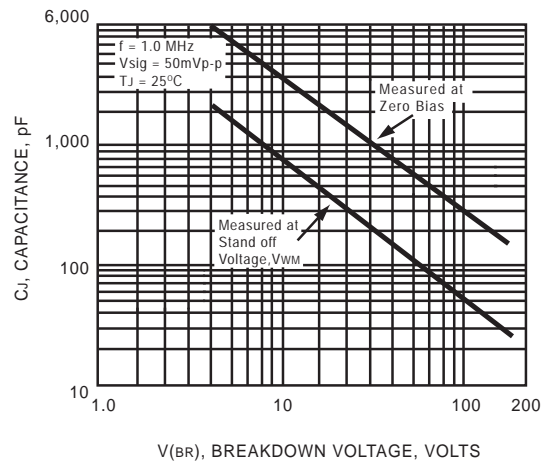

FIG. 4 - TYPICAL JUNCTION CAPACITANCE UNI-DIRECTIONAL



# RATING CHARACTERISTIC CURVES ( P6SBMJ6.8AGP ~ P6SBMJ200AGP )

FIG. 5 - STEADY STATE POWER DERATING CURVE

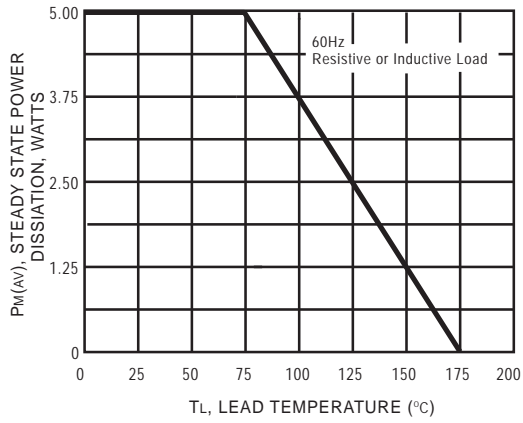

FIG. 6 - MAXIMUM NON-REPETITIVE FORWARD SURGE CURRENT UNI-DIRECTIONAL

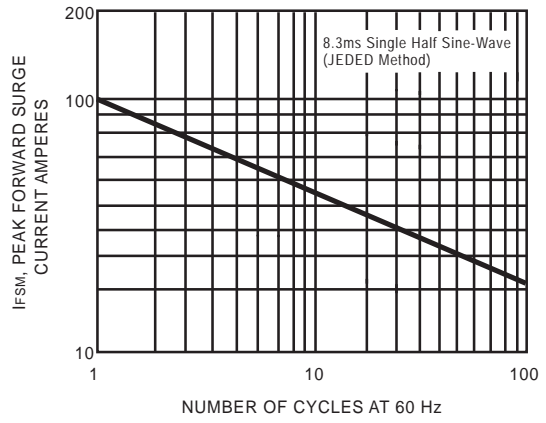

FIG. 7 - TYPICAL REVERSE LEAKAGE CHARACTERISTICS

