



CHENMKO ENTERPRISE CO.,LTD

GLASS PASSIVATED JUNCTION TRANSIENT VOLTAGE SUPPRESSOR
VOLTAGE-6.8 TO 200 VOLTS
600 WATTS PEAK POWER 5.0 WATTS STEADY STATE

P6SBMJ
CA SERIES

Halogens free devices

FEATURES

- * Plastic package
- * 600W surge capability at 1ms
- * Glass passivated chip junction in SMB Package
- * Excellent clamping capability
- * Low Zener Impedance
- * Fast response time: typically less than 1.0ps from 0 volts to BV min.
- * Typical IR less than 1 uA above 10V
- * High temperature soldering guaranteed : 260°C/10 seconds at terminals

MECHANICAL DATA

Case: JEDEC SMB molded plastic
Terminals: Plated axial leads, solderable per MIL-STD-750, Method 2026
Polarity: Bidirectional
Mounting Position: Any
Weight: 0.003 ounce 0.093 gram

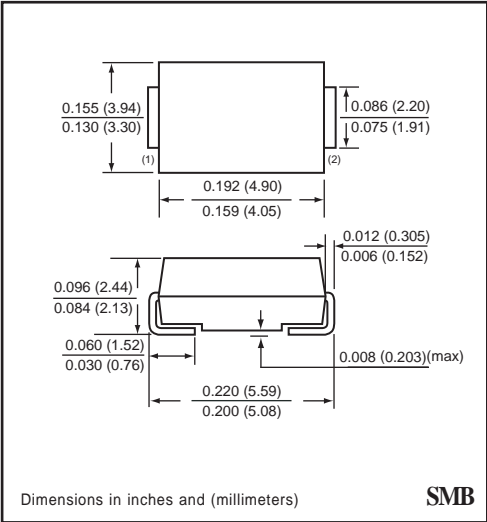
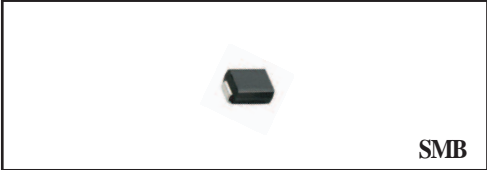

MAXIMUM RATINGS AND ELECTRICAL CHARACTERISTICS

Ratings at 25°C ambient temperature unless otherwise specified.
 Single phase, half wave, 60 Hz, resistive or inductive load.
 For capacitive load, derate current by 20%.

DEVICES FOR BIDIRECTIONAL APPLICATIONS

For Bidirectional use C or CA Suffix for types P6SBMJ6.8A thru types P6SBMJ200A
 Electrical characteristics apply in both directions.

MAXIMUM RATINGS (At TA = 25°C unless otherwise noted)

RATINGS	SYMBOL	VALUE	UNITS
Peak Power Dissipation at TA = 25°C, Tp = 1ms (Note1)	PPK	Minimum 600	Watts
Steady State Power Dissipation at TL = 75°C	PD	5.0	Watts
Peak Forward Surge Current 8.3ms Single Half Sine-Wave Superimposed on Rated Load (Note 2)	IFSM	100	Amps
Operating and Storage Temperature Range	TJ, TSTG	-65 to +175	°C

NOTES : 1. Non-repetitive current pulse, per Fig. 3 and derated above TA = 25°C per Fig. 2.
 2. 8.3ms single half sine-wave, duty cycle = 4 pulses per minute maximum.
 3. PC Board Mounted on 0.2 X 0.2" (5 X 5mm) copper pad area

PRODUCT NO.	Breakdown Voltage				Working Peak Reverse Voltage	Maximum Reverse Leakage at Vrwm	Maximum Reverse Current (NOTE 2)	Maximum Reverse Voltage at Irsm (clamping)	Maximum Temperature Coefficient of Vbr
	VBR Volts (NOTE 1)			@ IT (mA)					
	MIN.	NOM.	MAX.		Vrwm (V)	Ir (uA)	Irsm (A)	Vrsm (V)	(%C)
P6SBMJ6.8CAGP	6.45	6.8	7.14	10	5.80	2000	57	10.5	0.057
P6SBMJ7.5CAGP	7.13	7.5	7.88	10	6.40	1000	53	11.3	0.061
P6SBMJ8.2CAGP	7.79	8.2	8.61	10	7.02	400	50	12.1	0.065
P6SBMJ9.1CAGP	8.65	9.1	9.55	1.0	7.78	100	45	13.4	0.068
P6SBMJ10CAGP	9.5	10	10.5	1.0	8.55	20	41	14.5	0.073
P6SBMJ11CAGP	10.5	11	11.6	1.0	9.40	10	38	15.6	0.075
P6SBMJ12CAGP	11.4	12	12.6	1.0	10.2	5.0	36	16.7	0.078
P6SBMJ13CAGP	12.4	13	13.7	1.0	11.1	5.0	33	18.2	0.081
P6SBMJ15CAGP	14.3	15	15.8	1.0	12.8	5.0	28	21.2	0.084
P6SBMJ16CAGP	15.2	16	16.8	1.0	13.6	5.0	27	22.5	0.086
P6SBMJ18CAGP	17.1	18	18.9	1.0	15.3	5.0	24	25.2	0.088
P6SBMJ20CAGP	19.0	20	21.0	1.0	17.1	5.0	22	27.7	0.090
P6SBMJ22CAGP	20.9	22	23.1	1.0	18.8	5.0	20	30.6	0.092
P6SBMJ24CAGP	22.8	24	25.2	1.0	20.5	5.0	18	33.2	0.094
P6SBMJ27CAGP	25.7	27	28.4	1.0	23.1	5.0	16	37.5	0.096
P6SBMJ30CAGP	28.5	30	31.5	1.0	25.6	5.0	14.4	41.4	0.097
P6SBMJ33CAGP	31.4	33	34.7	1.0	28.2	5.0	13.2	45.7	0.098
P6SBMJ36CAGP	34.2	36	37.8	1.0	30.8	5.0	12.0	49.9	0.099
P6SBMJ39CAGP	37.1	39	41.0	1.0	33.3	5.0	11.2	53.9	0.100
P6SBMJ43CAGP	40.9	43	45.2	1.0	36.8	5.0	10.1	59.3	0.101
P6SBMJ47CAGP	44.7	47	49.4	1.0	40.2	5.0	9.3	64.8	0.101
P6SBMJ51CAGP	48.5	51	53.6	1.0	43.6	5.0	8.6	70.1	0.102
P6SBMJ56CAGP	53.2	56	58.8	1.0	47.8	5.0	7.8	77.0	0.103
P6SBMJ62CAGP	58.9	62	65.1	1.0	53.0	5.0	7.1	85.0	0.104
P6SBMJ68CAGP	64.6	68	71.4	1.0	58.0	5.0	6.5	92.0	0.104
P6SBMJ75CAGP	71.3	75	78.8	1.0	64.1	5.0	5.8	103	0.105
P6SBMJ82CAGP	77.9	82	86.1	1.0	70.1	5.0	5.3	113	0.105
P6SBMJ91CAGP	86.5	91	95.5	1.0	77.8	5.0	4.8	125	0.106
P6SBMJ100CAGP	95.0	100	105	1.0	85.5	5.0	4.4	137	0.106
P6SBMJ110CAGP	105	110	116	1.0	94.0	5.0	4.0	152	0.107
P6SBMJ120CAGP	114	120	126	1.0	102	5.0	3.6	165	0.107
P6SBMJ130CAGP	124	130	137	1.0	111	5.0	3.3	179	0.107
P6SBMJ150CAGP	143	150	158	1.0	128	5.0	2.9	207	0.108
P6SBMJ160CAGP	152	160	168	1.0	136	5.0	2.7	219	0.108
P6SBMJ170CAGP	162	170	179	1.0	145	5.0	2.6	234	0.108
P6SBMJ180CAGP	171	180	189	1.0	154	5.0	2.4	246	0.108
P6SBMJ200CAGP	190	200	210	1.0	171	5.0	2.2	274	0.108

RATING CHARACTERISTIC CURVES (P6SBMJ6.8CAGP ~ P6SBMJ200CAGP)

FIG. 1 - PEAK PULSE POWER RATING CURVE

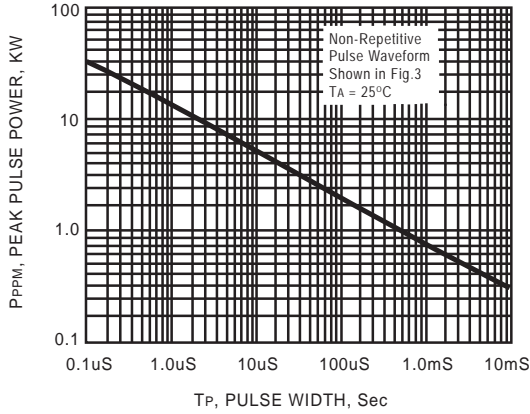

FIG. 2 - PULSE DERATING CURVE

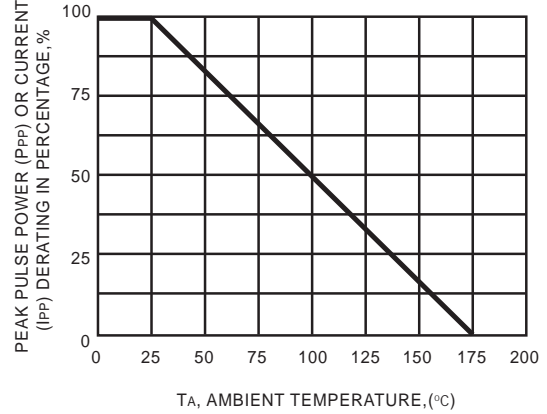

FIG. 3 - PULSE WAVEFORM

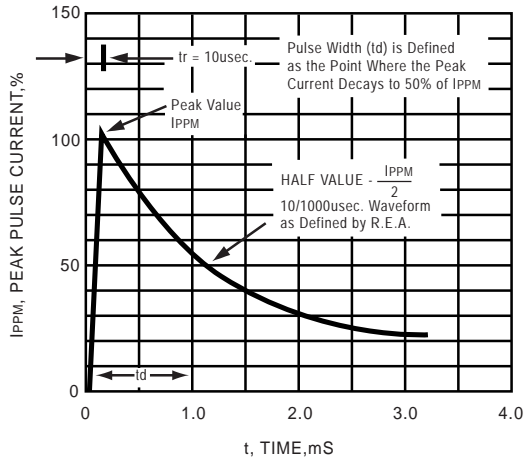
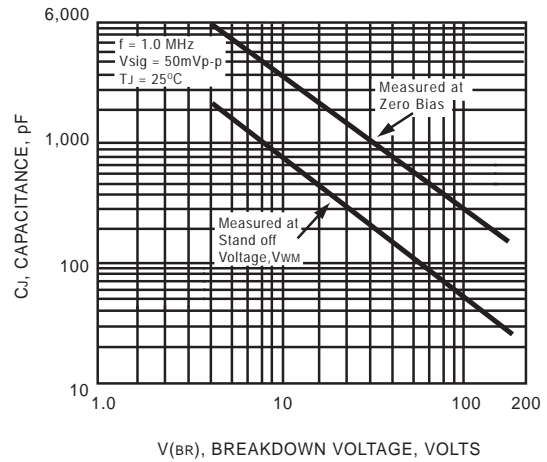

FIG. 4 - TYPICAL JUNCTION CAPACITANCE UNI-DIRECTIONAL



RATING CHARACTERISTIC CURVES (P6SBMJ6.8CAGP ~ P6SBMJ200CAGP)

FIG. 5 - STEADY STATE POWER DERATING CURVE

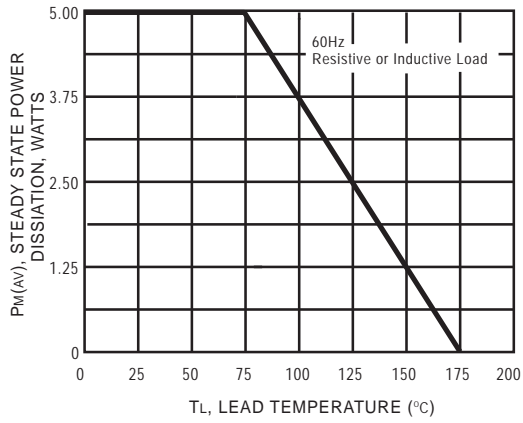

FIG. 6 - MAXIMUM NON-REPETITIVE FORWARD SURGE CURRENT UNI-DIRECTIONAL

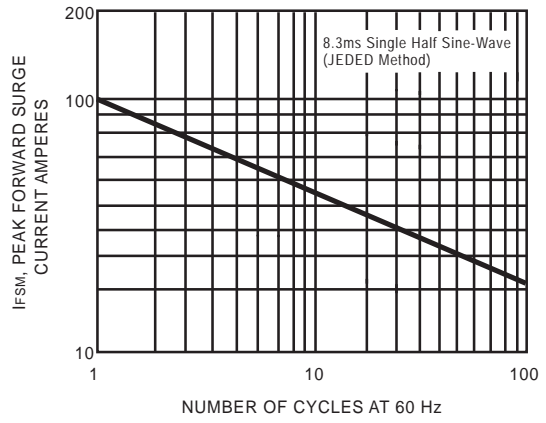

FIG. 7 - TYPICAL REVERSE LEAKAGE CHARACTERISTICS

