



CHENMKO ENTERPRISE CO.,LTD

GLASS PASSIVATED JUNCTION TRANSIENT VOLTAGE SUPPRESSOR
VOLTAGE-6.8 TO 200 VOLTS
600 WATTS PEAK POWER 5.0 WATTS STEADY STATE

P6SBMJ
CA SERIES

Halogens free devices

FEATURES

- * Plastic package
- * 600W surge capability at 1ms
- * Glass passivated chip junction in SMB Package
- * Excellent clamping capability
- * Low Zener Impedance
- * Fast response time: typically less than 1.0ps from 0 volts to BV min.
- * Typical IR less than 1 uA above 10V
- * High temperature soldering guaranteed : 260°C/10 seconds at terminals

MECHANICAL DATA

Case: JEDEC SMB molded plastic
Terminals: Plated axial leads, solderable per MIL-STD-750, Method 2026
Polarity: Bidirectional
Mounting Position: Any
Weight: 0.003 ounce 0.093 gram

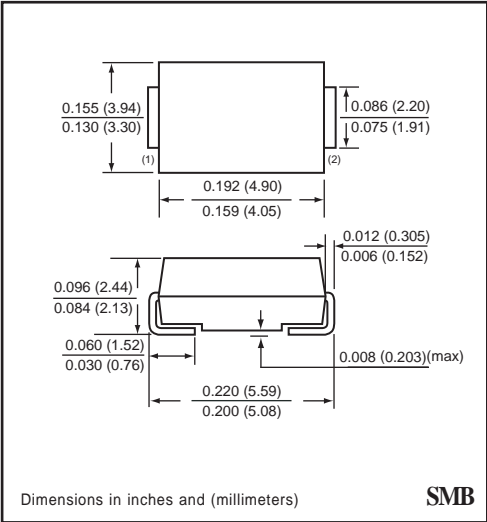
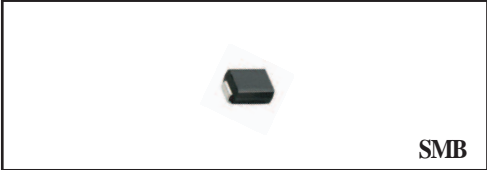

MAXIMUM RATINGS AND ELECTRICAL CHARACTERISTICS

Ratings at 25°C ambient temperature unless otherwise specified.
 Single phase, half wave, 60 Hz, resistive or inductive load.
 For capacitive load, derate current by 20%.

DEVICES FOR BIDIRECTIONAL APPLICATIONS

For Bidirectional use C or CA Suffix for types P6SBMJ6.8A thru types P6SBMJ200A
 Electrical characteristics apply in both directions.

MAXIMUM RATINGS (At TA = 25°C unless otherwise noted)

| RATINGS | SYMBOL | VALUE | UNITS |
|--|----------|-------------|-------|
| Peak Power Dissipation at TA = 25°C, Tp = 1ms (Note1) | PPK | Minimum 600 | Watts |
| Steady State Power Dissipation at TL = 75°C | PD | 5.0 | Watts |
| Peak Forward Surge Current 8.3ms Single Half Sine-Wave Superimposed on Rated Load (Note 2) | IFSM | 100 | Amps |
| Operating and Storage Temperature Range | TJ, TSTG | -65 to +175 | °C |

NOTES : 1. Non-repetitive current pulse, per Fig. 3 and derated above TA = 25°C per Fig. 2.
 2. 8.3ms single half sine-wave, duty cycle = 4 pulses per minute maximum.
 3. PC Board Mounted on 0.2 X 0.2" (5 X 5mm) copper pad area

| PRODUCT NO. | Breakdown Voltage | | | | Working Peak Reverse Voltage | Maximum Reverse Leakage at Vrwm | Maximum Reverse Current (NOTE 2) | Maximum Reverse Voltage at Irsm (clamping) | Maximum Temperature Coefficient of Vbr |
|---------------|-------------------------|------|------|----------------|------------------------------|---------------------------------|------------------------------------|--|--|
| | VBR Volts (NOTE 1) | | | @ IT (mA) | | | | | |
| | MIN. | NOM. | MAX. | | Vrwm (V) | Ir (uA) | Irsm (A) | Vrsm (V) | (%C) |
| P6SBMJ6.8CAGP | 6.45 | 6.8 | 7.14 | 10 | 5.80 | 2000 | 57 | 10.5 | 0.057 |
| P6SBMJ7.5CAGP | 7.13 | 7.5 | 7.88 | 10 | 6.40 | 1000 | 53 | 11.3 | 0.061 |
| P6SBMJ8.2CAGP | 7.79 | 8.2 | 8.61 | 10 | 7.02 | 400 | 50 | 12.1 | 0.065 |
| P6SBMJ9.1CAGP | 8.65 | 9.1 | 9.55 | 1.0 | 7.78 | 100 | 45 | 13.4 | 0.068 |
| P6SBMJ10CAGP | 9.5 | 10 | 10.5 | 1.0 | 8.55 | 20 | 41 | 14.5 | 0.073 |
| P6SBMJ11CAGP | 10.5 | 11 | 11.6 | 1.0 | 9.40 | 10 | 38 | 15.6 | 0.075 |
| P6SBMJ12CAGP | 11.4 | 12 | 12.6 | 1.0 | 10.2 | 5.0 | 36 | 16.7 | 0.078 |
| P6SBMJ13CAGP | 12.4 | 13 | 13.7 | 1.0 | 11.1 | 5.0 | 33 | 18.2 | 0.081 |
| P6SBMJ15CAGP | 14.3 | 15 | 15.8 | 1.0 | 12.8 | 5.0 | 28 | 21.2 | 0.084 |
| P6SBMJ16CAGP | 15.2 | 16 | 16.8 | 1.0 | 13.6 | 5.0 | 27 | 22.5 | 0.086 |
| P6SBMJ18CAGP | 17.1 | 18 | 18.9 | 1.0 | 15.3 | 5.0 | 24 | 25.2 | 0.088 |
| P6SBMJ20CAGP | 19.0 | 20 | 21.0 | 1.0 | 17.1 | 5.0 | 22 | 27.7 | 0.090 |
| P6SBMJ22CAGP | 20.9 | 22 | 23.1 | 1.0 | 18.8 | 5.0 | 20 | 30.6 | 0.092 |
| P6SBMJ24CAGP | 22.8 | 24 | 25.2 | 1.0 | 20.5 | 5.0 | 18 | 33.2 | 0.094 |
| P6SBMJ27CAGP | 25.7 | 27 | 28.4 | 1.0 | 23.1 | 5.0 | 16 | 37.5 | 0.096 |
| P6SBMJ30CAGP | 28.5 | 30 | 31.5 | 1.0 | 25.6 | 5.0 | 14.4 | 41.4 | 0.097 |
| P6SBMJ33CAGP | 31.4 | 33 | 34.7 | 1.0 | 28.2 | 5.0 | 13.2 | 45.7 | 0.098 |
| P6SBMJ36CAGP | 34.2 | 36 | 37.8 | 1.0 | 30.8 | 5.0 | 12.0 | 49.9 | 0.099 |
| P6SBMJ39CAGP | 37.1 | 39 | 41.0 | 1.0 | 33.3 | 5.0 | 11.2 | 53.9 | 0.100 |
| P6SBMJ43CAGP | 40.9 | 43 | 45.2 | 1.0 | 36.8 | 5.0 | 10.1 | 59.3 | 0.101 |
| P6SBMJ47CAGP | 44.7 | 47 | 49.4 | 1.0 | 40.2 | 5.0 | 9.3 | 64.8 | 0.101 |
| P6SBMJ51CAGP | 48.5 | 51 | 53.6 | 1.0 | 43.6 | 5.0 | 8.6 | 70.1 | 0.102 |
| P6SBMJ56CAGP | 53.2 | 56 | 58.8 | 1.0 | 47.8 | 5.0 | 7.8 | 77.0 | 0.103 |
| P6SBMJ62CAGP | 58.9 | 62 | 65.1 | 1.0 | 53.0 | 5.0 | 7.1 | 85.0 | 0.104 |
| P6SBMJ68CAGP | 64.6 | 68 | 71.4 | 1.0 | 58.0 | 5.0 | 6.5 | 92.0 | 0.104 |
| P6SBMJ75CAGP | 71.3 | 75 | 78.8 | 1.0 | 64.1 | 5.0 | 5.8 | 103 | 0.105 |
| P6SBMJ82CAGP | 77.9 | 82 | 86.1 | 1.0 | 70.1 | 5.0 | 5.3 | 113 | 0.105 |
| P6SBMJ91CAGP | 86.5 | 91 | 95.5 | 1.0 | 77.8 | 5.0 | 4.8 | 125 | 0.106 |
| P6SBMJ100CAGP | 95.0 | 100 | 105 | 1.0 | 85.5 | 5.0 | 4.4 | 137 | 0.106 |
| P6SBMJ110CAGP | 105 | 110 | 116 | 1.0 | 94.0 | 5.0 | 4.0 | 152 | 0.107 |
| P6SBMJ120CAGP | 114 | 120 | 126 | 1.0 | 102 | 5.0 | 3.6 | 165 | 0.107 |
| P6SBMJ130CAGP | 124 | 130 | 137 | 1.0 | 111 | 5.0 | 3.3 | 179 | 0.107 |
| P6SBMJ150CAGP | 143 | 150 | 158 | 1.0 | 128 | 5.0 | 2.9 | 207 | 0.108 |
| P6SBMJ160CAGP | 152 | 160 | 168 | 1.0 | 136 | 5.0 | 2.7 | 219 | 0.108 |
| P6SBMJ170CAGP | 162 | 170 | 179 | 1.0 | 145 | 5.0 | 2.6 | 234 | 0.108 |
| P6SBMJ180CAGP | 171 | 180 | 189 | 1.0 | 154 | 5.0 | 2.4 | 246 | 0.108 |
| P6SBMJ200CAGP | 190 | 200 | 210 | 1.0 | 171 | 5.0 | 2.2 | 274 | 0.108 |

RATING CHARACTERISTIC CURVES (P6SBMJ6.8CAGP ~ P6SBMJ200CAGP)

FIG. 1 - PEAK PULSE POWER RATING CURVE

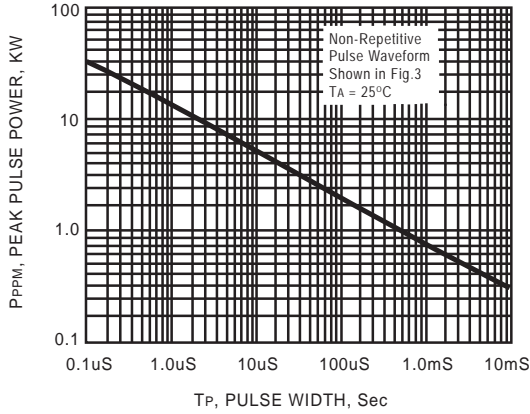

FIG. 2 - PULSE DERATING CURVE

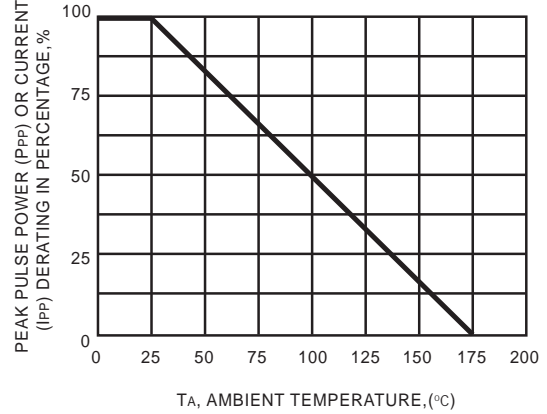

FIG. 3 - PULSE WAVEFORM

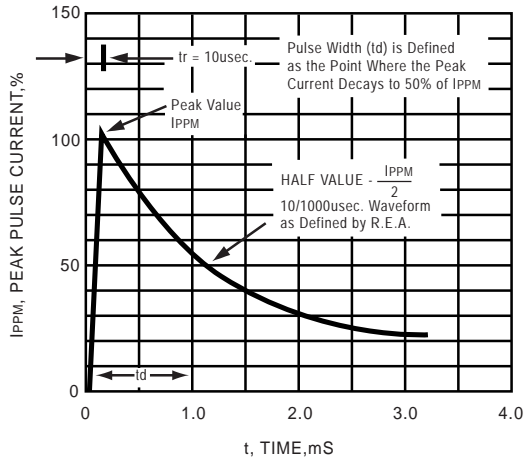
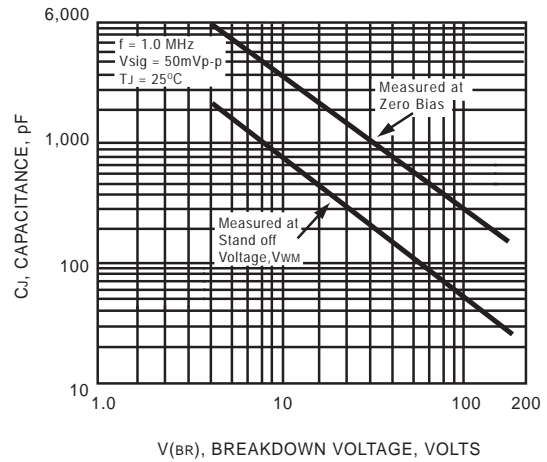

FIG. 4 - TYPICAL JUNCTION CAPACITANCE UNI-DIRECTIONAL



RATING CHARACTERISTIC CURVES (P6SBMJ6.8CAGP ~ P6SBMJ200CAGP)

FIG. 5 - STEADY STATE POWER DERATING CURVE

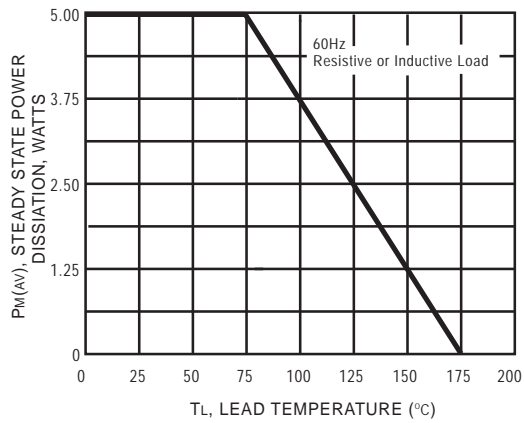

FIG. 6 - MAXIMUM NON-REPETITIVE FORWARD SURGE CURRENT UNI-DIRECTIONAL

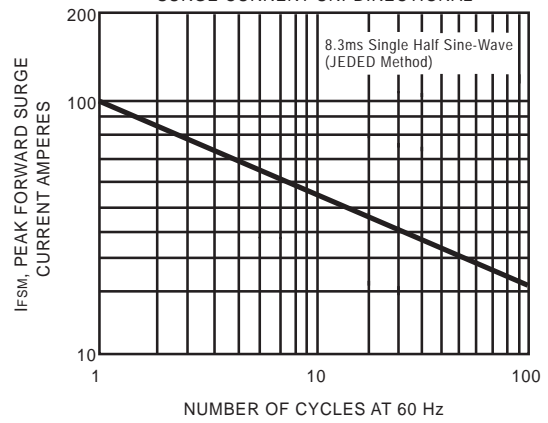

FIG. 7 - TYPICAL REVERSE LEAKAGE CHARACTERISTICS

